

HYDRAULIC WEDGE JACKS

Griphold make Wedge Jack specially designed to create an initial opening in narrow gaps.

- Double acting cylinder.
- Rigid Alloy Steel Body.
- Rigid Aluminium alloy cylinder.

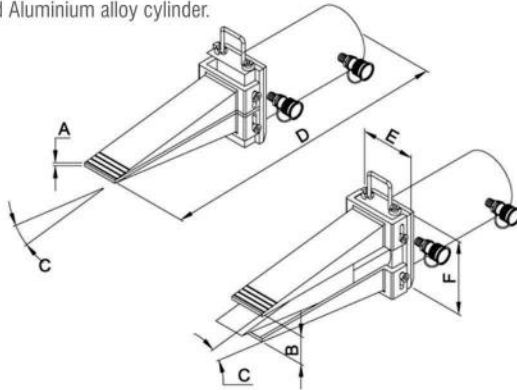

Model No.	Spreading Force (ton)	Working Pressure (bar)	Insertion Height A (mm)	Lifting Height B (mm)	Wedge Angle C (degree)	Overall Length D (mm)	Body Width E (mm)	Body Height F (mm)	Weight, Ready for use (Kg)
GWJ-20-S	20	720	12	56	15	647	110	150	14.6